

BS EN 61000-3-3:2008



BSI British Standards

Electromagnetic compatibility (EMC) —

Part 3-3: Limits — Limitation of voltage changes, voltage fluctuations and flicker in public low-voltage supply systems, for equipment with rated current ≤ 16 A per phase and not subject to conditional connection

NO COPYING WITHOUT BSI PERMISSION EXCEPT AS PERMITTED BY COPYRIGHT LAW

raising standards worldwide™

Copyright European Committee for Electrotechnical Standardization
Provided by IHS under license with CENELEC
No reproduction or networking permitted without license from IHS

Not for Resale

BSI
British Standards

National foreword

This British Standard is the UK implementation of EN 61000-3-3:2008. It is identical to IEC 61000-3-3:2008. It supersedes BS EN 61000-3-3:1995, which will be withdrawn on 1 September 2011.

The UK participation in its preparation was entrusted by Technical Committee GEL/210, EMC - Policy committee, to Subcommittee GEL/210/12, EMC basic, generic and low frequency phenomena Standardization.

A list of organizations represented on this committee can be obtained on request to its secretary.

This publication does not purport to include all the necessary provisions of a contract. Users are responsible for its correct application.

© BSI 2008

ISBN 978 0 580 59102 0

ICS 33.100.10

Compliance with a British Standard cannot confer immunity from legal obligations.

This British Standard was published under the authority of the Standards Policy and Strategy Committee on 31 December 2008.

Amendments issued since publication

Date	Text affected
-------------	----------------------

English version

**Electromagnetic compatibility (EMC) -
Part 3-3: Limits -
Limitation of voltage changes, voltage fluctuations and flicker in public
low-voltage supply systems, for equipment with rated current ≤ 16 A
per phase and not subject to conditional connection
(IEC 61000-3-3:2008)**

Compatibilité électromagnétique (CEM) -
Partie 3-3: Limites -
Limitation des variations de tension,
des fluctuations de tension
et du papillotement dans les réseaux
publics d'alimentation basse tension,
pour les matériels ayant un courant
assigné ≤ 16 A par phase et non soumis
à un raccordement conditionnel
(CEI 61000-3-3:2008)

Elektromagnetische Verträglichkeit (EMV) -
Teil 3-3: Grenzwerte -
Begrenzung von Spannungsänderungen,
Spannungsschwankungen und Flicker
in öffentlichen Niederspannungs-
Versorgungsnetzen für Geräte
mit einem Bemessungsstrom ≤ 16 A
je Leiter, die keiner
Sonderanschlussbedingung unterliegen
(IEC 61000-3-3:2008)

This European Standard was approved by CENELEC on 2008-09-01. CENELEC members are bound to comply with the CEN/CENELEC Internal Regulations which stipulate the conditions for giving this European Standard the status of a national standard without any alteration.

Up-to-date lists and bibliographical references concerning such national standards may be obtained on application to the Central Secretariat or to any CENELEC member.

This European Standard exists in three official versions (English, French, German). A version in any other language made by translation under the responsibility of a CENELEC member into its own language and notified to the Central Secretariat has the same status as the official versions.

CENELEC members are the national electrotechnical committees of Austria, Belgium, Bulgaria, Cyprus, the Czech Republic, Denmark, Estonia, Finland, France, Germany, Greece, Hungary, Iceland, Ireland, Italy, Latvia, Lithuania, Luxembourg, Malta, the Netherlands, Norway, Poland, Portugal, Romania, Slovakia, Slovenia, Spain, Sweden, Switzerland and the United Kingdom.

CENELEC

European Committee for Electrotechnical Standardization
Comité Européen de Normalisation Electrotechnique
Europäisches Komitee für Elektrotechnische Normung

Central Secretariat: rue de Stassart 35, B - 1050 Brussels

Foreword

The text of document 77A/644/FDIS, future edition 2 of IEC 61000-3-3, prepared by SC 77A, Low frequency phenomena, of IEC TC 77, Electromagnetic compatibility, was submitted to the IEC-CENELEC parallel vote and was approved by CENELEC as EN 61000-3-3 on 2008-09-01.

This European Standard supersedes EN 1000-3-3:1995 + corrigendum July 1997 + A1:2001 + IS1:2005 + A2:2005.

The following dates were fixed:

- latest date by which the EN has to be implemented
at national level by publication of an identical
national standard or by endorsement (dop) 2009-06-01
- latest date by which the national standards conflicting
with the EN have to be withdrawn (dow) 2011-09-01

This European Standard has been prepared under a mandate given to CENELEC by the European Commission and the European Free Trade Association and covers essential requirements of EC Directives 2004/108/EC and 1999/5/EC. See Annex ZZ.

Annexes ZA and ZZ have been added by CENELEC.

Endorsement notice

The text of the International Standard IEC 61000-3-3:2008 was approved by CENELEC as a European Standard without any modification.

Annex ZA
(normative)

**Normative references to international publications
with their corresponding European publications**

The following referenced documents are indispensable for the application of this document. For dated references, only the edition cited applies. For undated references, the latest edition of the referenced document (including any amendments) applies.

NOTE When an international publication has been modified by common modifications, indicated by (mod), the relevant EN/HD applies.

<u>Publication</u>	<u>Year</u>	<u>Title</u>	<u>EN/HD</u>	<u>Year</u>
IEC 60050-161	1990	International Electrotechnical Vocabulary (IEV) - Chapter 161: Electromagnetic compatibility	-	-
IEC/TR 60725	- ¹⁾	Consideration of reference impedances and public supply network impedances for use in determining disturbance characteristics of electrical equipment having a rated current ≤ 75 A per phase	-	-
IEC 60974-1	- ¹⁾	Arc welding equipment - Part 1: Welding power sources	EN 60974-1	2005 ²⁾
IEC 61000-3-2	2005	Electromagnetic compatibility (EMC) - Part 3-2: Limits - Limits for harmonic current emissions (equipment input current ≤ 16 A per phase)	EN 61000-3-2	2006
IEC 61000-3-11	- ¹⁾	Electromagnetic compatibility (EMC) - Part 3-11: Limits - Limitation of voltage changes, voltage fluctuations and flicker in public low-voltage supply systems - Equipment with rated current ≤ 75 A and subject to conditional connection	EN 61000-3-11	2000 ²⁾
IEC 61000-4-15	- ¹⁾	Electromagnetic compatibility (EMC) - Part 4-15: Testing and measurement techniques - Flickermeter - Functional and design specifications	EN 61000-4-15	1998 ²⁾

¹⁾ Undated reference.

²⁾ Valid edition at date of issue.

Annex ZZ
(informative)

Coverage of Essential Requirements of EC Directives

This European Standard has been prepared under a mandate given to CENELEC by the European Commission and the European Free Trade Association and within its scope the standard covers the essential requirements as given in Annex I Article 1(a) of the EC Directive 2004/108/EC and the essential requirements of Article 3.1(b) (emission only) of the EC Directive 1999/5/EC.

Compliance with this standard provides one means of conformity with the specified essential requirements of the Directives concerned.

WARNING: Other requirements and other EC Directives may be applicable to the products falling within the scope of this standard.

CONTENTS

INTRODUCTION.....	5
1 Scope.....	6
2 Normative references	6
3 Definitions	7
4 Assessment of voltage changes, voltage fluctuations and flicker	8
4.1 Assessment of a relative voltage change, "d"	8
4.2 Assessment of the short-term flicker value, P_{st}	9
4.2.1 Flickermeter	9
4.2.2 Simulation method.....	9
4.2.3 Analytical method	9
4.2.4 Use of $P_{st} = 1$ curve.....	10
4.3 Assessment of long-term flicker value, P_{lt}	10
5 Limits	10
6 Test conditions	11
6.1 General	11
6.2 Measurement accuracy	12
6.3 Test supply voltage	12
6.4 Reference impedance.....	12
6.5 Observation period	12
6.6 General test conditions.....	13
Annex A (normative) Application of limits and type test conditions for specific equipment.....	18
Annex B (normative) Test conditions and procedures for measuring d_{max} voltage changes caused by manual switching	25
Figure 1 – Reference network for single-phase and three-phase supplies derived from a three-phase, four-wire supply.....	14
Figure 2 – Histogram evaluation of $U(t)$	15
Figure 3 – Relative voltage change characteristic	15
Figure 4 – Curve for $P_{st}=1$ for rectangular equidistant voltage changes	16
Figure 5 – Shape factors F for double-step and ramp-voltage characteristics.....	16
Figure 6 – Shape factors F for rectangular and triangular voltage characteristics.....	17
Figure 7 – Shape factor F for motor-start voltage characteristics having various front times.....	17
Table 1 – Assessment method.....	9
Table A.1 – Electrode parameters.....	23
Table A.2 – Frequency factor R related to repetition rate "r"	24

INTRODUCTION

IEC 61000 is published in separate parts according to the following structure:

Part 1: General

General considerations (introduction, fundamental principles)

Definitions, terminology

Part 2: Environment

Description of the environment

Classification of the environment

Compatibility levels

Part 3: Limits

Emission limits

Immunity limits (in so far as they do not fall under the responsibility of product committees)

Part 4: Testing and measurement techniques

Measurement techniques

Testing techniques

Part 5: Installation and mitigation guidelines

Installation guidelines

Mitigation methods and devices

Part 9: Miscellaneous

Each part is further subdivided into sections which are to be published either as International Standards or as Technical Reports.

These standards and reports will be published in chronological order and numbered accordingly.

This part is a Product Family Standard.

The limits in this standard relate to the voltage changes experienced by consumers connected at the interface between the public supply low-voltage network and the equipment user's installation. Consequently, if the actual impedance of the supply at the supply terminals of equipment connected within the equipment user's installation exceeds the test impedance, it is possible that supply disturbance exceeding the limits may occur.

ELECTROMAGNETIC COMPATIBILITY (EMC) –

Part 3-3: Limits – Limitation of voltage changes, voltage fluctuations and flicker in public low-voltage supply systems, for equipment with rated current ≤ 16 A per phase and not subject to conditional connection

1 Scope

This part of IEC 61000 is concerned with the limitation of voltage fluctuations and flicker impressed on the public low-voltage system.

It specifies limits of voltage changes which may be produced by an equipment tested under specified conditions and gives guidance on methods of assessment.

This part of IEC 61000 is applicable to electrical and electronic equipment having an input current equal to or less than 16 A per phase, intended to be connected to public low-voltage distribution systems of between 220 V and 250 V line to neutral at 50 Hz, and not subject to conditional connection.

Equipment which does not comply with the limits of this part of IEC 61000 when tested with the reference impedance Z_{ref} of 6.4, and which therefore cannot be declared compliant with this part, may be retested or evaluated to show conformity with IEC 61000-3-11. Part 3-11 is applicable to equipment with rated input current ≤ 75 A per phase and subject to conditional connection.

The tests according to this part are type tests. Particular test conditions are given in annex A and the test circuit is shown in Figure 1.

NOTE The limits in this part of IEC 61000 are based mainly on the subjective severity of flicker imposed on the light from 230 V/60 W coiled-coil filament lamps by fluctuations of the supply voltage. For systems with nominal voltage less than 220 V line to neutral and/or frequency of 60 Hz, the limits and reference circuit values are under consideration.

2 Normative references

The following referenced documents are indispensable for the application of this document. For dated references, only the edition cited applies. For undated references, the latest edition of the referenced document (including any amendments) applies.

IEC 60050(161):1990, *International Electrotechnical Vocabulary (IEV) – Chapter 161: Electromagnetic compatibility*

IEC/TR 60725, *Consideration of reference impedances and public supply impedances for use in determining disturbance characteristics of electrical equipment having a rated current ≤ 75 A per phase*

IEC 60974-1, *Arc welding equipment – Part 1: Welding power sources*

IEC 61000-3-2:2005, *Electromagnetic compatibility (EMC) – Part 3-2: Limits – Limits for harmonic current emissions (equipment input current ≤ 16 A per phase)*

IEC 61000-3-11, *Electromagnetic compatibility (EMC) – Part 3-11: Limits – Limitation of voltage changes, voltage fluctuations and flicker in public low-voltage supply systems – Equipment with rated current ≤ 75 A and subject to conditional connection*

IEC 61000-4-15, *Electromagnetic compatibility (EMC) – Part 4: Testing and measurement techniques – Section 15: Flickermeter – Functional and design specifications*

3 Definitions

For the purpose of this part of IEC 61000-3, the following definitions apply.

3.1

r.m.s. voltage shape, $U(t)$

the time function of r.m.s. voltage, evaluated as a single value for each successive half period between zero-crossings of the source voltage (see Figure 2)

3.2

voltage change characteristic, $\Delta U(t)$

the time function of the r.m.s. voltage change evaluated as a single value for each successive half period between zero-crossings of the source voltage between time intervals in which the voltage is in a steady-state condition for at least 1 s (see Figure 2)

NOTE Since this characteristic is only used for assessments using calculations, the voltage in the steady-state condition is assumed to be constant within the measurement accuracy (see 6.2).

3.3

maximum voltage change characteristic, ΔU_{\max}

the difference between maximum and minimum r.m.s. values of a voltage change characteristic (see Figure 2)

3.4

steady-state voltage change, ΔU_c

the difference between two adjacent steady-state voltages separated by at least one voltage change characteristic (see Figure 2)

NOTE Definitions 3.2 to 3.4 relate to absolute phase-to-neutral voltages. The ratios of these magnitudes to the phase-to-neutral value of the nominal voltage (U_n) of the reference network in Figure 1 are called:

- relative voltage change characteristic: $d(t)$ (definition 3.2);
- maximum relative voltage change: d_{\max} (definition 3.3);
- relative steady-state voltage change: d_c (definition 3.4).

These definitions are explained by the example in Figure 3.

3.5

voltage fluctuation

series of changes of r.m.s. voltage evaluated as a single value for each successive half-period between zero-crossings of the source voltage

3.6

flicker

impression of unsteadiness of visual sensation induced by a light stimulus whose luminance or spectral distribution fluctuates with time. [IEV 161-08-13]

3.7

short-term flicker indicator, P_{st}

the flicker severity evaluated over a short period (in minutes); $P_{st} = 1$ is the conventional threshold of irritability

3.8**long-term flicker indicator, P_{lt}**

the flicker severity evaluated over a long period (a few hours) using successive P_{st} values

3.9**flickermeter:**

an instrument designed to measure any quantity representative of flicker

NOTE Measurements are normally P_{st} and P_{lt} . [IEV 161-08-14]

3.10**flicker impression time, t_f**

value with a time dimension which describes the flicker impression of a voltage change characteristic

3.11**conditional connection**

connection of equipment requiring the user's supply at the interface point to have an impedance lower than the reference impedance Z_{ref} in order that the equipment emissions comply with the limits in this part.

NOTE Meeting the voltage change limits may not be the only condition for connection; emission limits for other phenomena such as harmonics, may also have to be satisfied.

3.12**interface point**

interface between a public supply network and a user's installation

4 Assessment of voltage changes, voltage fluctuations and flicker**4.1 Assessment of a relative voltage change, "d"**

The basis for flicker evaluation is the voltage change characteristic at the terminals of the equipment under test, that is the difference ΔU of any two successive values of the phase-to-neutral voltages $U(t_1)$ and $U(t_2)$:

$$\Delta U = U(t_1) - U(t_2) \quad (1)$$

The r.m.s. values $U(t_1)$, $U(t_2)$ of the voltage shall be measured or calculated. When deducing r.m.s. values from oscillographic waveform, account should be taken of any waveform distortion that may be present. The voltage change ΔU is due to the change of the voltage drop across the complex reference impedance Z , caused by the complex fundamental input current change, $\Delta \underline{I}$, of the equipment under test. ΔI_p and ΔI_q are the active and reactive parts respectively of the current change, $\Delta \underline{I}$.

$$\Delta \underline{I} = \Delta I_p - j \cdot \Delta I_q = \underline{I}(t_1) - \underline{I}(t_2) \quad (2)$$

NOTE 1 I_q is positive for lagging currents and negative for leading currents.

NOTE 2 If the harmonic distortion of the currents $\underline{I}(t_1)$ and $\underline{I}(t_2)$ is less than 10 %, the total r.m.s. value may be applied instead of the r.m.s. values of their fundamental currents.

NOTE 3 For single-phase and symmetrical three-phase equipment the voltage change can, provided X is positive (inductive), be approximated to:

$$\Delta U = |\Delta I_p \cdot R + \Delta I_q \cdot X| \quad (3)$$

where

ΔI_p and ΔI_q are the active and reactive parts respectively of the current change $\Delta \underline{I}$;

R and X are the elements of the complex reference impedance Z (see Figure 1).

The relative voltage change is given by:

$$"d" = \Delta U / U_n \quad (4)$$

4.2 Assessment of the short-term flicker value, P_{st}

The short-term flicker value P_{st} is defined in IEC 61000-4-15.

Table 1 shows alternative methods for evaluating P_{st} , due to voltage fluctuations of different types:

Table 1 – Assessment method

Types of voltage fluctuations	Methods of evaluation P_{st}
All voltage fluctuations (on-line evaluation)	Direct measurement
All voltage fluctuations where $U(t)$ is defined	Simulation Direct measurement
Voltage change characteristics according to Figures 5 to 7 with an occurrence rate less than 1 per second	Analytical method Simulation Direct measurement
Rectangular voltage change at equal intervals	Use of the $P_{st} = 1$ curve of Figure 4

4.2.1 Flickermeter

All types of voltage fluctuations may be assessed by direct measurement using a flickermeter which complies with the specification given in IEC 61000-4-15, and is connected as described in Clause 6 of this part. This is the reference method for application of the limits.

4.2.2 Simulation method

In the case where the relative voltage change characteristic $d(t)$ is known, P_{st} can be evaluated using a computer simulation.

4.2.3 Analytical method

For voltage change characteristics of the types shown in Figures 5, 6 and 7, the P_{st} value can be evaluated by an analytical method using equations (5) and (6).

NOTE 1 The value of P_{st} obtained using this method is expected to be within $\pm 10\%$ of the result which would be obtained by direct measurement (reference method).

NOTE 2 This method is not recommended if the time duration between the end of one voltage change and the start of the next is less than 1 s.

4.2.3.1 Description of the analytical method

Each relative voltage change characteristic shall be expressed by a flicker impression time, t_f , in seconds:

$$t_f = 2,3 (F \cdot d_{\max})^{3,2} \quad (5)$$

- the maximum relative voltage change d_{\max} is expressed as a percentage of the nominal voltage;
- the shape factor, F , is associated with the shape of the voltage change characteristic (see 4.2.3.2).

The sum of the flicker impression times, Σt_f , of all evaluation periods within a total interval of the length T_p , in seconds, is the basis for the P_{st} evaluation. If the total time interval T_p is chosen according to 6.5, it is an "observation period", and:

$$P_{st} = (\Sigma t_f / T_p)^{1/3,2} \quad (6)$$

4.2.3.2 Shape factor

The shape factor, F , converts a relative voltage change characteristic $d(t)$ into a flicker equivalent relative step voltage change ($F \cdot d_{\max}$).

NOTE 1 The shape factor, F , is equal to 1,0 for step voltage changes.

NOTE 2 The relative voltage change characteristic may be measured directly (see Figure 1) or calculated from the r.m.s. current of the equipment under test (see equations (1) to (4)).

The relative voltage change characteristic shall be obtained from a histogram of $U(t)$ (see Figure 3).

The shape factor may be deduced from Figures 5, 6 and 7, provided that the relative voltage change characteristic matches a characteristic shown in the Figures. If the characteristics match, proceed as follows:

- find the maximum relative voltage change d_{\max} (according to Figure 3); and
- find the time T (ms) appropriate to the voltage change characteristic as shown in Figures 5, 6 and 7 and, using this value, obtain the required shape factor, F .

NOTE 3 Extrapolation outside the range of the Figures may lead to unacceptable errors.

4.2.4 Use of $P_{st} = 1$ curve

In the case of rectangular voltage changes of the same amplitude " d " separated by equal time intervals, the curve of Figure 4 may be used to deduce the amplitude corresponding to $P_{st} = 1$ for a particular rate of repetition; this amplitude is called d_{lim} . The P_{st} value corresponding to the voltage change " d " is then given by $P_{st} = d/d_{lim}$.

4.3 Assessment of long-term flicker value, P_{lt}

The long-term flicker value P_{lt} is defined in IEC 61000-4-15 and shall be applied with the value of $N = 12$ (see 6.5).

It is generally necessary to assess the value of P_{lt} for equipment which is normally operated for more than 30 min at a time.

5 Limits

The limits shall be applicable to voltage fluctuations and flicker at the supply terminals of the equipment under test, measured or calculated according to Clause 4 under test conditions described in Clause 6 and Annex A. Tests made to prove compliance with the limits are considered to be type tests.

The following limits apply:

- the value of P_{st} shall not be greater than 1,0;
- the value of P_{lt} shall not be greater than 0,65;
- the value of $d(t)$ during a voltage change shall not exceed 3,3 % for more than 500 ms;
- the relative steady-state voltage change, d_c , shall not exceed 3,3 %;
- the maximum relative voltage change d_{\max} , shall not exceed
 - a) 4 % without additional conditions;
 - b) 6 % for equipment which is:
 - switched manually, or
 - switched automatically more frequently than twice per day, and also has either a delayed restart (the delay being not less than a few tens of seconds), or manual restart, after a power supply interruption.

NOTE The cycling frequency will be further limited by the P_{st} and P_{lt} limit. For example: a d_{max} of 6 % producing a rectangular voltage change characteristic twice per hour will give a P_{lt} of about 0,65.

c) 7 % for equipment which is

- attended whilst in use (for example: hair dryers, vacuum cleaners, kitchen equipment such as mixers, garden equipment such as lawn mowers, portable tools such as electric drills), or
- switched on automatically, or is intended to be switched on manually, no more than twice per day, and also has either a delayed restart (the delay being not less than a few tens of seconds) or manual restart, after a power supply interruption.

In the case of equipment having several separately controlled circuits in accordance with 6.6, limits b) and c) shall apply only if there is delayed or manual restart after a power supply interruption; for all equipment with automatic switching which is energised immediately on restoration of supply after a power supply interruption, limits a) shall apply; for all equipment with manual switching, limits b) or c) shall apply depending on the rate of switching.

P_{st} and P_{lt} requirements shall not be applied to voltage changes caused by manual switching.

The limits shall not be applied to voltage changes associated with emergency switching or emergency interruptions.

6 Test conditions

6.1 General

Tests need not be made on equipment which is unlikely to produce significant voltage fluctuations or flicker.

It may be necessary to determine, by examination of the circuit diagram and specification of the equipment and by a short functional test, whether significant voltage fluctuations are likely to be produced.

For voltage changes caused by manual switching, equipment is deemed to comply without further testing if the maximum r.m.s. input current (including inrush current) evaluated over each 10 ms half-period between zero-crossings does not exceed 20 A, and the supply current after inrush is within a variation band of 1,5 A.

If measurement methods are used, the maximum relative voltage change d_{max} caused by manual switching shall be measured in accordance with Annex B.

Tests to prove the compliance of the equipment with the limits shall be made using the test circuit in Figure 1.

The test circuit consists of:

- the test supply voltage (see 6.3);
- the reference impedance (see 6.4);
- the equipment under test (see Annex A);
- if necessary, a flickermeter (see IEC 61000-4-15).

The relative voltage change $d(t)$ may be measured directly or derived from the r.m.s. current as described in 4.1. To determine the P_{st} value of the equipment under test, one of the methods described in 4.2 shall be used. In case of doubt, the P_{st} shall be measured using the reference method with a flickermeter.

NOTE If balanced multiphase equipment is tested, it is acceptable to measure only one of the three line-to-neutral voltages.

6.2 Measurement accuracy

The magnitude of the current shall be measured with an accuracy of $\pm 1\%$ or better. If instead of active and reactive current the phase angle is used, its error shall not exceed $\pm 2^\circ$.

The relative voltage change "d" shall be determined with a total accuracy better than $\pm 8\%$ with reference to the maximum value d_{\max} . The total impedance of the circuit, excluding the appliance under test, but including the internal impedance of the supply source, shall be equal to the reference impedance. The stability and tolerance of this total impedance shall be adequate to ensure that the overall accuracy of $\pm 8\%$ is achieved during the whole assessment procedure.

NOTE The following method is not recommended where the measured values are close to the limits.

When the source impedance is not well defined, for example where the source impedance is subject to unpredictable variations, an impedance having resistance and inductance equal to the reference impedance may be connected between the supply and the terminals of the equipment under test. Measurements can then be made of the voltages at the source side of the reference impedance and at the equipment terminals. In that case, the maximum relative voltage change, d_{\max} , measured at the supply terminals shall be less than 20 % of the maximum value d_{\max} measured at the equipment terminals.

6.3 Test supply voltage

The test supply voltage (open-circuit voltage) shall be the rated voltage of the equipment. If a voltage range is stipulated for the equipment, the test voltage shall be 230 V single-phase or 400 V three-phase. The test voltage shall be maintained within $\pm 2\%$ of the nominal value. The frequency shall be $50 \text{ Hz} \pm 0,5\%$.

The percentage total harmonic distortion of the supply voltage shall be less than 3 %.

Fluctuations of the test supply voltage during a test may be neglected if the P_{st} value is less than 0,4. This condition shall be verified before and after each test.

6.4 Reference impedance

For equipment under test the reference impedance, Z_{ref} , according to IEC 60725, is a conventional impedance used in the calculation and measurement of the relative voltage change "d", and the P_{st} and P_{lt} values.

The impedance values of the various elements are given in Figure 1.

6.5 Observation period

The observation period, T_p , for the assessment of flicker values by flicker measurement, flicker simulation, or analytical method shall be:

- for P_{st} , $T_p = 10 \text{ min}$;
- for P_{lt} , $T_p = 2 \text{ h}$.

The observation period shall include that part of the whole operation cycle in which the equipment under test produces the most unfavourable sequence of voltage changes.

For the assessment of P_{st} , the cycle of operation shall be repeated continuously, unless stated otherwise in Annex A. The minimum time to restart the equipment shall be included in this observation period when testing equipment that stops automatically at the end of a cycle of operation which lasts for less than the observation period.

For P_{ft} assessment, the cycle of operation shall not be repeated, unless stated otherwise in Annex A, when testing equipment with a cycle of operation of less than 2 h and which is not normally used continuously.

NOTE For example, in the case of equipment with a cycle of operation lasting 45 min, five consecutive P_{st} values will be measured during a total period of 50 min, and the remaining seven P_{st} values in the 2 h observation period will be deemed to be zero.

6.6 General test conditions

The test conditions for the measurement of voltage fluctuations and flicker are given below. For equipment not mentioned in Annex A, controls or automatic programs shall be set to produce the most unfavourable sequence of voltage changes, using only those combinations of controls and programmes which are mentioned by the manufacturer in the instruction manual, or are otherwise likely to be used. Particular test conditions for equipment not included in Annex A are under consideration.

The equipment shall be tested in the condition in which it is supplied by the manufacturer. Preliminary operation of motor drives may be needed before the tests to ensure that results corresponding to those of normal use are obtained.

NOTE Operating conditions include mechanical and/or electrical loading conditions.

For motors, locked-rotor measurements may be used to determine the largest r.m.s. voltage change, d_{max} , occurring during motor starting.

For equipment having several separately controlled circuits, the following conditions apply:

- each circuit shall be considered as a single item of equipment if it is intended to be used independently, provided that the controls are not designed to switch at the same instant;
- if the control of separate circuits are designed to switch simultaneously, the group of circuits so controlled are considered as a single item of equipment.

For control systems regulating part of a load only, the voltage fluctuations produced by each variable part of the load alone shall be considered.

Detailed type test conditions for some equipment are given in Annex A.

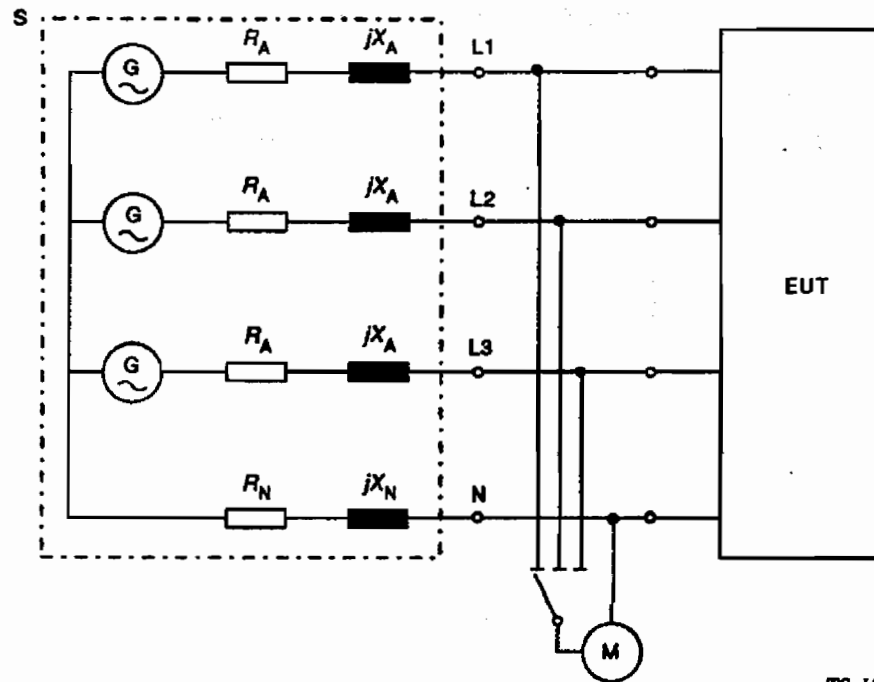

IEC 1015/M

EUT equipment under test

M measuring equipment

S supply source consisting of the supply voltage generator G and reference impedance Z with the elements:

$$R_A = 0,24 \, \Omega; \quad jX_A = 0,15 \, \Omega \text{ at } 50 \text{ Hz};$$

$$R_N = 0,16 \, \Omega; \quad jX_N = 0,10 \, \Omega \text{ at } 50 \text{ Hz}.$$

The elements include the actual generator impedance.

When the source impedance is not well defined, see 6.2.

G voltage source in accordance with 6.3.

NOTE In general, three-phase loads are balanced, and R_N and X_N can be neglected, as there is no current in the neutral wire.

Figure 1 – Reference network for single-phase and three-phase supplies derived from a three-phase, four-wire supply

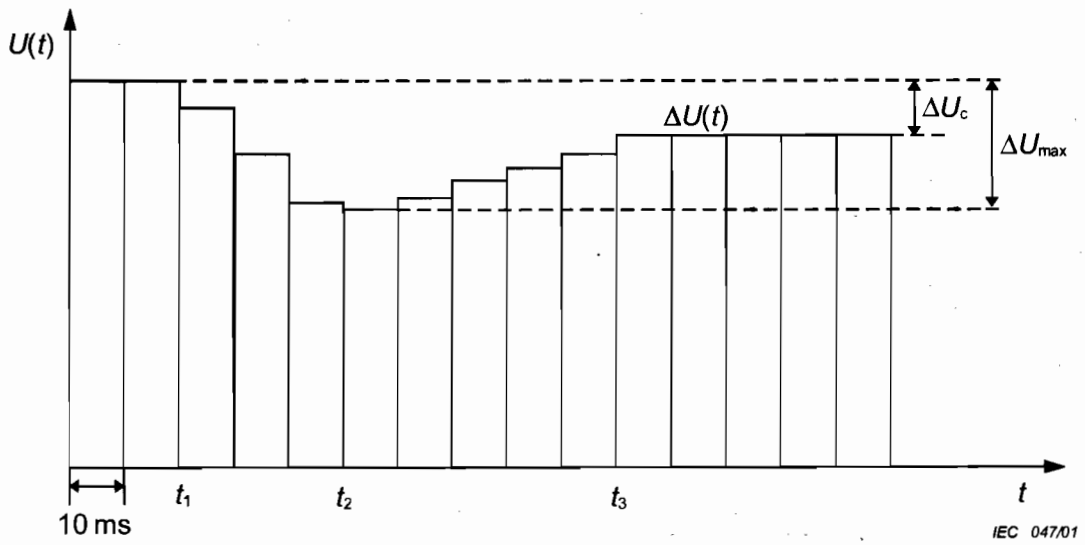

Figure 2 – Histogram evaluation of $U(t)$

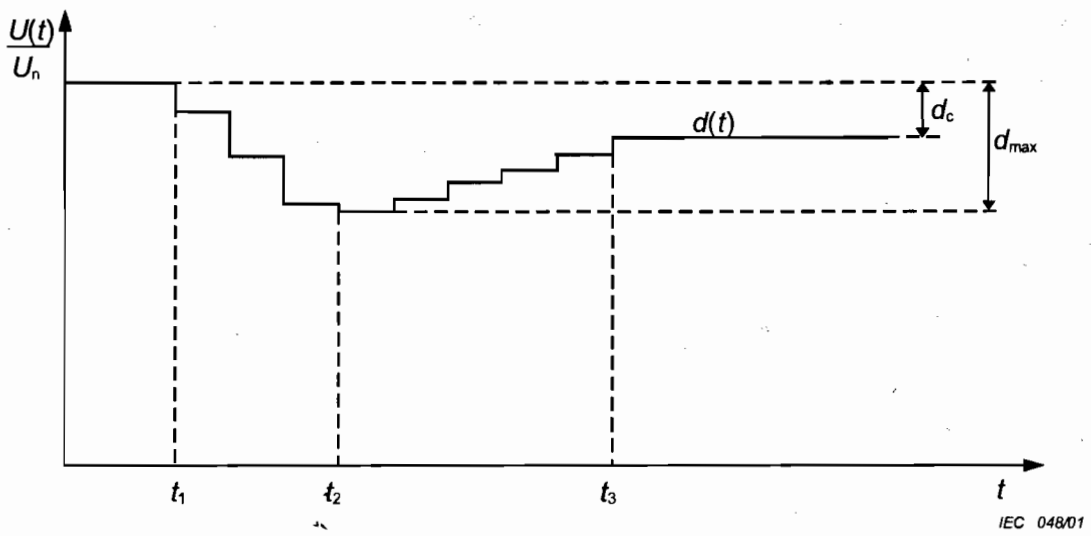
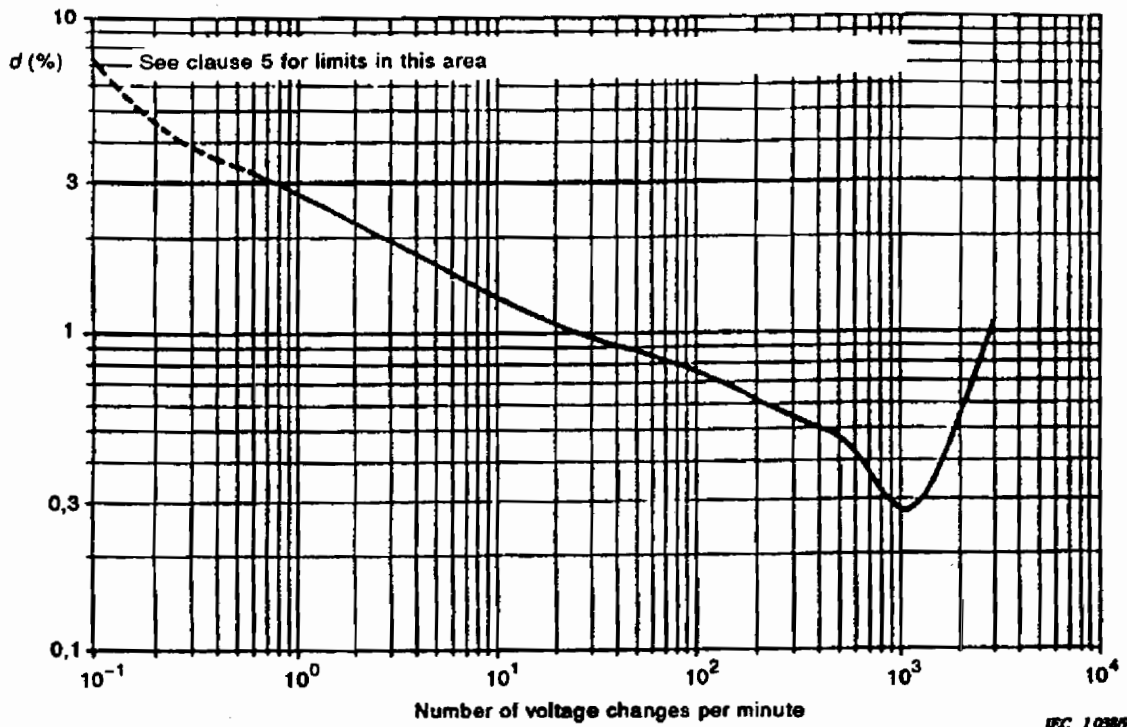

Figure 3 – Relative voltage change characteristic



NOTE 1 200 voltage changes per minute give 10 Hz flicker.

Figure 4 – Curve for $P_{st}=1$ for rectangular equidistant voltage changes

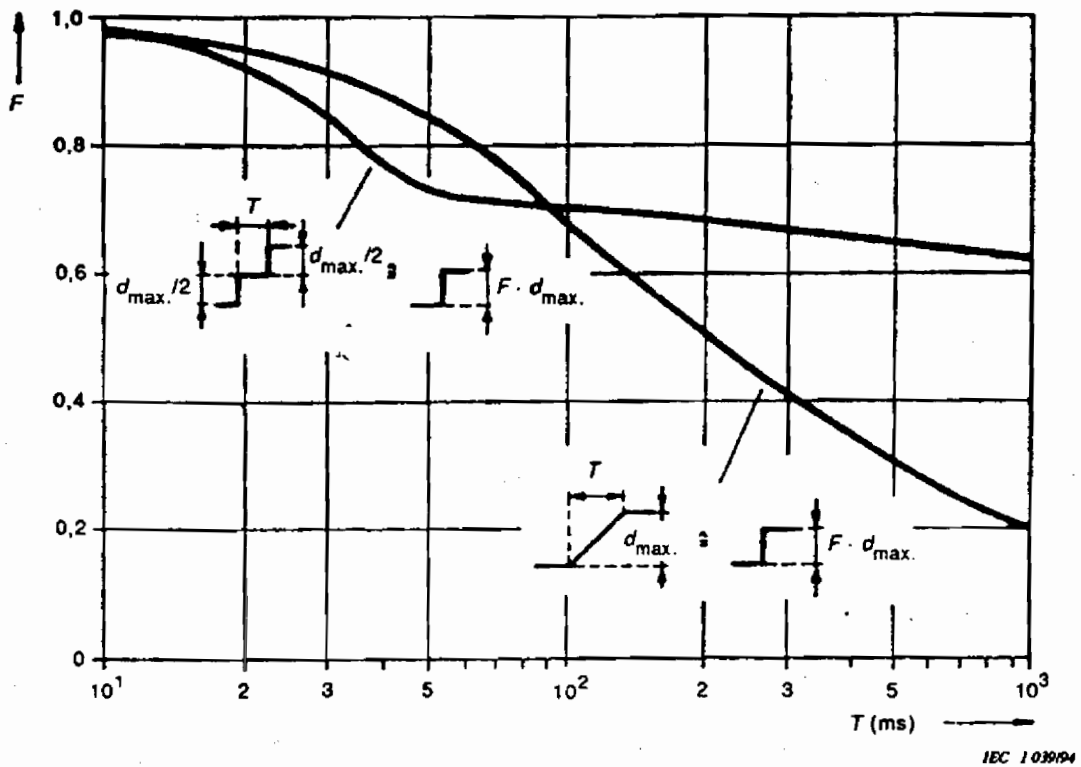

Figure 5 – Shape factors F for double-step and ramp-voltage characteristics

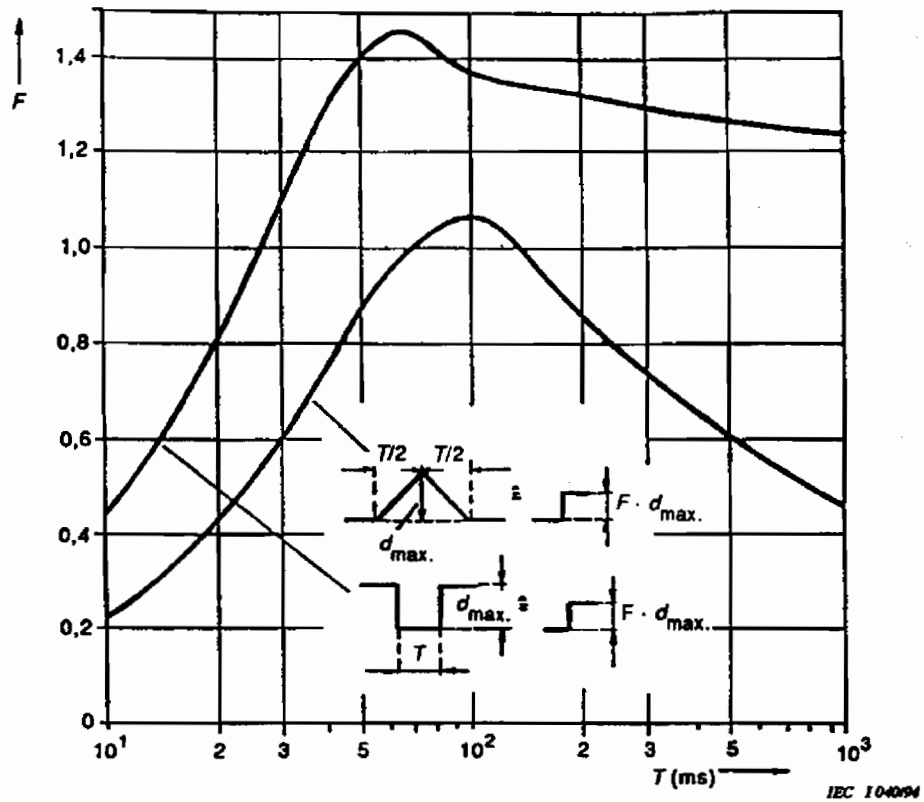
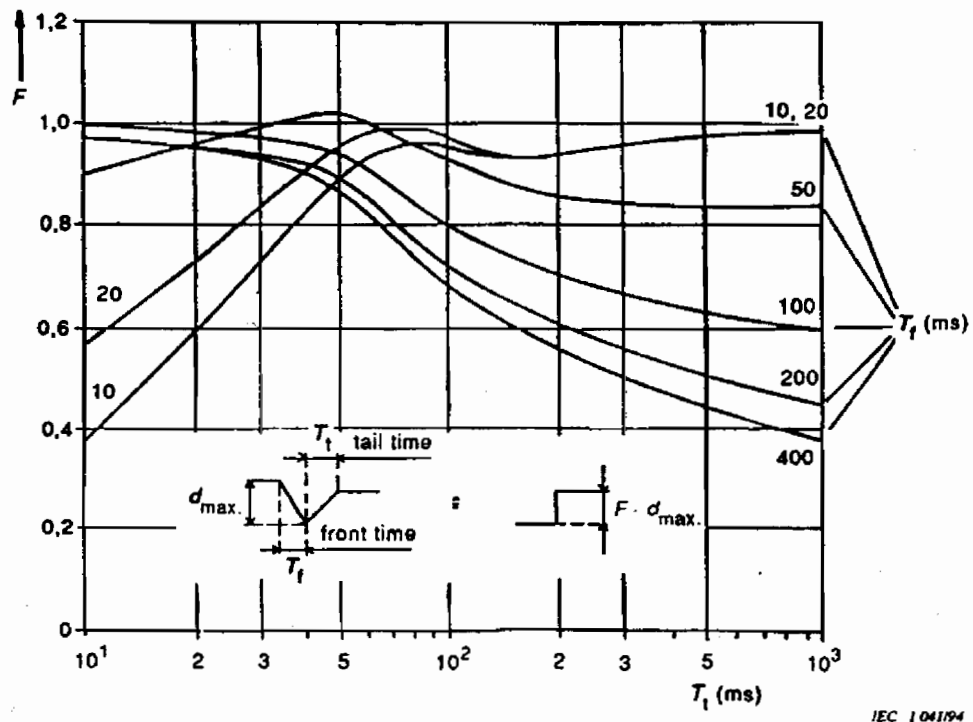

Figure 6 – Shape factors F for rectangular and triangular voltage characteristics



NOTE $T_t = t_3 - t_2$, $T_f = t_2 - t_1$ (see Figure 3).

Figure 7 – Shape factor F for motor-start voltage characteristics having various front times

Annex A (normative)

Application of limits and type test conditions for specific equipment

A.1 Test conditions for cookers

For cookers designed for use in domestic premises, the evaluation of P_{lt} shall not be required.

The tests of P_{st} shall be performed at steady-state temperature conditions, unless stated otherwise.

Each heater shall be tested separately as follows.

A.1.1 Hotplates

Hotplates shall be tested using standard saucepans with diameter, height and water quantity as follows:

Diameter of the hotplate (mm)	Height of the pot (mm)	Quantity of water (g)
145	about 140	1 000 ± 50
180	about 140	1 500 ± 50
220	about 120	2 000 ± 50

Possible losses by evaporation have to be compensated for during the time of measurement.

In all of the following tests the hotplate shall comply with the limits given in Clause 5.

- Boiling temperature range: set the control to the position where the water just boils. The test is made five times and the mean value of the test results calculated.
- Frying temperature range: fill the pot, without a lid, with silicone oil to 1,5 times the quantity of water shown in the Table. Set the control to a temperature of 180 °C measured by a thermocouple in the geometric centre of the oil.
- Total range of power settings: the total power range shall be checked continuously during a 10 min observation period. If control switches have discrete stages, test all stages up to a maximum of 20 stages. If there are no discrete stages, divide the total range into 10 equally spaced steps. The measurements shall then be made starting at the highest power stage.

A.1.2 Baking ovens

The oven shall be tested empty with the door closed. Adjust the control so that a thermocouple fixed in the geometric centre measures a mean temperature of 220 °C for conventional ovens and 200 °C for hot air oven.

A.1.3 Grills

The grill shall be tested empty with the door closed, if not otherwise stated by the manufacturer. If a control is available it shall be set to the lowest, the medium and the highest setting for grilling operation; and the worst result recorded.

A.1.4 Baking oven/grill combinations

The oven/grill combination shall be tested empty with the door closed. Adjust the control so that a thermocouple fixed in the geometric centre measures a mean temperature of 250 °C, or that available temperature closest to this value.

A.1.5 Microwave ovens

The microwave oven or the microwave function of a combination oven shall be tested at the lowest, the medium and a third stage which is the highest adjustable power less than or equal to 90 % of the maximum power. Load the oven with a glass bowl containing $1\ 000 \pm 50$ g of water.

A.2 Test conditions for lighting and similar equipment

The following test conditions shall apply to equipment with a primary function of generating and/or regulating and/or distributing optical radiation by means of incandescent or discharge lamps or LEDs.

Such equipment shall be tested with a lamp of that power for which the equipment is rated. If lighting equipment includes more than one lamp, all lamps shall be in use.

P_{st} and P_{lt} evaluations are required only for lighting equipment which is likely to produce flicker; for example: disco lighting and automatically regulated equipment.

No limits shall apply to lamps.

Incandescent lamp luminaires with ratings less than or equal to 1 000 W and discharge lamp luminaires with ratings less than or equal to 600 W, are deemed to comply with the d_{max} limits in this standard and are not required to be tested. Luminaires with higher ratings, which cannot comply with this part of IEC 61000, shall be subject to conditional connection in accordance with IEC 61000-3-11.

Ballasts are deemed to be part of luminaires and are not required to be tested.

A.3 Test conditions for washing machines

The washing machine shall be tested during a complete laundry program incorporating the normal wash-cycle, filled with the rated load of double hemmed, pre-washed cotton cloths, size approximately 70 cm × 70 cm, dry weight from 140 g/m² to 175 g/m².

The temperature of the fill water shall be:

- 65 °C ± 5 °C for washing machines without heater elements and intended for connection to a hot water supply;
- 15 °C +10°C, – 5 °C for other washing machines.

For washing machines with a programmer, the 60 °C cotton programme without pre-wash, if available, shall be used, otherwise the regular wash programme without pre-wash shall be used. If the washing machine contains heating elements which are not controlled by the programmer, the water shall be heated to 65 °C ± 5 °C before starting the first wash period.

If the washing machine contains heating elements and does not incorporate a programmer, the water shall be heated to 90 °C ± 5 °C or lower if steady conditions are established, before starting the first wash period.

Neglect simultaneous switching of heater and motor in the evaluation of d_c , d_{max} and $d(t)$.

P_{st} and P_{lt} shall be evaluated.

A.4 Test conditions for tumbler dryers

The tumble dryer shall be operated with the drum filled with textile material having a mass in the dry condition of 50 % of the maximum load stated in the instruction for use.

The textile material consists of pre-washed double-hemmed cotton sheets, approximately 70 cm × 70 cm, having a mass between 140 g/m² and 175 g/m² in the dry condition. The material shall be soaked with water having a temperature of 25 °C ± 5 °C and a mass of 60 % of that of the textile material.

If a control of the drying degree is available, the test shall be performed at the maximum and minimum settings.

P_{st} and P_{lt} shall be evaluated.

A.5 Test conditions for refrigerators

Refrigerators shall operate continuously with the door closed. Adjust the thermostat to the mid-value of the adjusting range. The cabinet shall be empty and not heated. The measurement shall be made after a steady state has been reached. P_{st} and P_{lt} shall not be evaluated.

A.6 Test conditions for copying machines, laser printers and similar appliances

The appliance shall be tested for P_{st} at the maximum rate of copying. The original to be copied/printed is white blank paper and the copy paper shall have a weight of 80 g/m² if not otherwise stated by the manufacturer.

Obtain the P_{lt} value in the stand-by mode.

A.7 Test conditions for vacuum cleaners

For vacuum cleaners, P_{st} and P_{lt} shall not be evaluated.

A.8 Test conditions for food mixers

For food mixers, P_{st} and P_{lt} shall not be evaluated.

A.9 Test conditions for portable tools

For portable tools, P_{lt} shall not be evaluated. For portable tools without heating elements, P_{st} shall not be evaluated. For portable tools with heating elements, P_{st} shall be evaluated as follows.

Switch on the tool and allow to operate continuously for 10 min, or until it switches off automatically, in which case 6.5 applies.

A.10 Test conditions for hairdryers

For hand-held hairdryers, P_{It} shall not be evaluated. To evaluate P_{St} , switch on the hairdryer and allow to operate continuously for 10 min or until it switches off automatically, in which case 6.5 applies.

For hairdryers incorporating a power range, check the total power range continuously during a 10 min observation period. If control switches have discrete stages all stages shall be tested up to a maximum of 20 stages. If there are no discrete stages, divide the total range into 10 equally spaced steps. The measurements shall then be made, starting with the highest power stage.

A.11 Test conditions for television sets, audio-equipment, computers, DVDs and similar electronic equipment

Such equipment, intended for use by residential consumers, shall be tested to prove compliance only with the appropriate d_{max} limit in Clause 5 if no other special test conditions in this Annex are applicable.

A.12 Test conditions for direct water heaters

For direct water heaters without electronic controls, evaluate d_c only by switching the heater on and off (sequence 0 – P_{max} – 0).

For direct water heaters with electronic controls, the output temperature of the water has to be chosen so that by means of the variation of water flow-rate all electric power consumption rates between P_{min} and P_{max} may be produced. P_{max} is defined as the maximum power which can be chosen, and $P_{min} > 0$ is defined as the minimum power which can be chosen.

NOTE For some appliances, the maximum power P_{max} which can be chosen may be less than the rated power.

The set temperature value shall be kept unchanged during the total test.

Starting from the water flow-rate demand for maximum power consumption, P_{max} , reduce the rate of flow in 20 approximately equal steps to minimum power consumption, P_{min} .

Then, in another 20 approximately equal steps, increase the water flow-rate again to power consumption P_{max} . For each of these 40 stages the $P_{st,i}$ value shall be evaluated; the measurements start when the steady state is reached, that is about 30 s after changing the water flow-rate.

NOTE It may be sufficient to calculate $P_{st,i}$ value on the base of a measurement period of only 1 min.

Additionally, the flicker $P_{st,z}$ caused by switching the heater on and off has to be measured within a 10 min interval. In this interval, the power consumption has to be changed twice in the quickest possible way between the stages $P = 0$ and $P = P_{max}$ (sequence 0 – P_{max} – 0 – P_{max} – 0).

The duty cycle of the heater shall be 50 % that is P_{max} during 5 min.

Evaluate the resultant P_{St} values by:

$$P_{St} = \left(P_{st,z}^3 + \frac{1}{40} \cdot \sum_{i=1}^{i=40} (P_{st,i})^3 \right)^{\frac{1}{3}}$$

and compare against the limit value in Clause 5.

P_{lt} shall not be evaluated.

A.13 Test conditions for audio-frequency amplifiers

Audio amplifiers shall be tested under the same operating conditions as are specified in Clause C.3 of IEC 61000-3-2.

A.14 Test conditions for air conditioners, dehumidifiers, heat pumps, and commercial refrigerating equipment

Operate the equipment until a steady-state condition has been established or for a minimum compressor run time of 30 minutes.

The ambient temperature for testing shall be $15\text{ °C} \pm 5\text{ °C}$ for heating and $30\text{ °C} \pm 5\text{ °C}$ for cooling or dehumidification.

Reverse cycle heat pumps shall be tested only in cooling mode.

d_{max} shall be evaluated in one of the following ways:

a) by direct measurement:

- turn the motor of the compressor off using the thermostat;
- turn the motor of the compressor on again using the thermostat after the minimum off-time prescribed in the user manual or allowed by the automatic control;
- repeat the off/on sequence 24 times and evaluate the results in accordance with Annex B. However, if the first test result is not within $\pm 10\%$ of the limit, the equipment may be assessed for compliance on the basis of this single result and the test may be terminated.

b) by the analytical method:

- using as starting current, the locked rotor current and power factor of the motor of the compressor and of any other loads (such as a fan motor) which are turned on less than 2 s before or after the motor of the compressor starts; this procedure separates the voltage changes.

P_{st} and P_{lt} shall be analytically evaluated using the number of cycles per hour declared by the manufacturer.

A.15 Test conditions for arc welding equipment and allied processes

For arc-welding equipment, attended whilst in use, and allied processes, d_{max} shall be evaluated against the 7 % limit in c) of Clause 5, using the test method given in Annex B.

Additionally, equipment designed to be used for the Manual Metal Arc (MMA) process, P_{st} and d_c values shall be evaluated according to the procedures given in A.15.1 and A.15.2.

For all tests, the voltage drop caused by the equipment under normal operating conditions at rated maximum output power shall be within 3 % to 5 % of the supply voltage.

Although the scope of this standard is limited to equipment with input current equal to or less than 16 A, these test conditions shall also be valid for equipment with input current greater than 16 A.

The following test conditions shall be applicable to welding equipment designed according to IEC 60974-1. Test conditions for other types of equipment are under consideration.

A.15.1 Evaluation of P_{st}

Tests to evaluate the P_{st} value for MMA welding equipment should be made using a test setup simulating welding with 3,25 mm basic electrodes. If the EUT is not suitable for these electrodes ($I_{2max} < 130$ A), parameters representing a 2,5 mm electrode shall be used.

Table A.1 – Electrode parameters

Diameter mm	Basic data				
	I_{nom} A	U_{nom} V	Drops l/min	t_{drop} ms	$R_{short\ circuit}$ mΩ
2,5	90	23,6	920	5,6	18
3,25	130	25,2	350	7,5	13

The value of the voltage change at the input terminals of the EUT, ΔU , which is crucial to the determination of P_{st} , shall be measured or calculated from input current measurements at the supply input terminals of the EUT using one of the following test procedures.

In all cases the arc-force dial, if existing, shall be set to the medium position, the connection to the dummy load should be made with two 3 m welding cables of 50 mm² Cu.

A.15.1.1 Test procedure A

This simple test procedure can give pessimistically high test results and may therefore also be used for preliminary testing.

The r.m.s. input current is measured firstly with the EUT loaded with a resistive load equivalent to the nominal output current and voltage and secondly loaded with the specified short-circuit resistance, $R_{short\ circuit}$ given in Table A.1. The difference of the measured r.m.s. input current values, ΔI_{input} , is used to derive ΔU values in the evaluation process.

A.15.1.2 Test procedure B

This test procedure is more complicated than Test A but it gives more realistic results.

The parameters given in Table A.1 shall be simulated by an electronically switched resistive load capable of changing from "nominal load" values to "short-circuit" values with the specified resistance for the specified droplet time at defined phase angles with respect to the input voltage.

The input current changes (10 ms r.m.s. samples) caused by these load-changes on the output shall be measured with dropstarts at zero-crossing and delays of 2 ms, 4 ms, 6 ms and 8 ms. The average arithmetical value of the resulting current changes shall be used in the evaluation process.

A.15.1.3 P_{st} evaluation process

The P_{st} of the EUT shall be calculated by use of the following equation:

$$P_{st} = 0,365 \times \Delta U \times F \times r^{0,31} \times R$$

where

$$\Delta U = \Delta I_{\text{input}} \times Z_{\text{ref}} \times 100/U_n \%$$

F is an equivalence factor, depending on the shape of the voltage change characteristic; for MMA welding $F = 1,0$;

r is the frequency of the voltage changes per minute;

R is a coefficient depending on the repetition frequency, values of which are presented in Table A.2.

Table A.2 – Frequency factor R related to repetition rate " r "

r in voltage changes per minute	R	r in voltage changes per minute	R
0,2	0,98	2	0,99
0,3	1,03	3	1,00
0,4	1,02	4	1,00
0,5	1,00	5	1,03
0,6	1,00	6	1,02
0,7	1,02	7	1,02
0,8	1,00	8	1,03
0,9	1,00	9	1,03
1,0	1,00	10	1,08

NOTE In practice the MMA welding process is composed of workpiece preparation, welding time, time to work on the seam and time to change electrodes. Therefore, the estimated time of use during which voltage changes are produced is only 2,5 min in every 10 min period represented by a duty cycle of 0,25; the value of r for this typical operation is 0,2 changes/minute as only the voltage changes at the start and finish of a period of continuous welding are significant.

The result shall comply with the limit in Clause 5. If the limit is exceeded, the equipment cannot be declared compliant with this part of IEC 61000 and the procedure according to IEC 61000-3-11 shall be applied.

A.15.2 Test procedure for d_c

The r.m.s. input current shall be measured firstly with the EUT loaded with a resistive load equivalent to the rated maximum output current and voltage and secondly with load equivalent to idling conditions. The difference between the r.m.s. input current values shall be used in the evaluation process.

A.15.2.1 Evaluation of d_c

d_c shall be determined by application of the following equation:

$$d_c = \Delta I_{\text{input}} \times Z_{\text{ref}} \times 100/U_N$$

The result shall comply with the limit in Clause 5. If the limit is exceeded, the equipment cannot be declared compliant with this part of IEC 61000 and the procedure according to IEC 61000-3-11 shall be applied.

Annex B (normative)

Test conditions and procedures for measuring d_{\max} voltage changes caused by manual switching

B.1 Introduction

The considerable variations in the designs and characteristics of manually operated switches cause wide variations in the results of voltage change measurements. A test procedure dependent on the actual operation of the EUT's manually operated switch is essential.

Therefore a statistical method shall be applied to the measurement of d_{\max} in order to achieve repeatability of test results.

B.2 Procedure

- a) 24 measurements of inrush current data shall be carried out in the following order:
- start a measurement;
 - switch on the EUT (to create a voltage change);
 - let the EUT operate as long as possible under normal operating conditions during a measuring time interval of 1 min;
 - switch off the EUT before the end of the 1 min measuring time interval and make sure that all moving parts inside the EUT come to standstill and that any d_{\max} mitigation devices have had time to cool to the ambient temperature before the next measuring interval is started;
 - start the next measurement.

NOTE The method of cooling may be natural or forced, and the cooling period should be specified by the equipment manufacturer if desired.

- b) The final test result shall be calculated by deleting the highest and lowest results and take the arithmetical average of the remaining 22 values.

British Standards Institution (BSI)

BSI is the independent national body responsible for preparing British Standards. It presents the UK view on standards in Europe and at the international level.

It is incorporated by Royal Charter.

Revisions

British Standards are updated by amendment or revision. Users of British Standards should make sure that they possess the latest amendments or editions.

It is the constant aim of BSI to improve the quality of our products and services. We would be grateful if anyone finding an inaccuracy or ambiguity while using this British Standard would inform the Secretary of the technical committee responsible, the identity of which can be found on the inside front cover.

Tel: +44 (0)20 8996 9000 Fax: +44 (0)20 8996 7400

BSI offers members an individual updating service called PLUS which ensures that subscribers automatically receive the latest editions of standards.

Buying standards

Orders for all BSI, international and foreign standards publications should be addressed to BSI Customer Services.

Tel: +44 (0)20 8996 9001 Fax: +44 (0)20 8996 7001

Email: orders@bsigroup.com

You may also buy directly using a debit/credit card from the BSI Shop on the website www.bsigroup.com/shop

In response to orders for international standards, it is BSI policy to supply the BSI implementation of those that have been published as British Standards, unless otherwise requested.

Information on standards

BSI provides a wide range of information on national, European and international standards through its Library.

Various BSI electronic information services are also available which give details on all its products and services. Contact the Information Centre.

Tel: +44 (0)20 8996 7111

Fax: +44 (0)20 8996 7048 Email: info@bsigroup.com

Subscribing members of BSI are kept up to date with standards developments and receive substantial discounts on the purchase price of standards. For details of these and other benefits contact Membership Administration.

Tel: +44 (0)20 8996 7002 Fax: +44 (0)20 8996 7001

Email: membership@bsigroup.com

Information regarding online access to British Standards via British Standards Online can be found at www.bsigroup.com/BSOL

Further information about BSI is available on the BSI website at www.bsigroup.com

Copyright

Copyright subsists in all BSI publications. BSI also holds the copyright, in the UK, of the publications of the international standardization bodies. Except as permitted under the Copyright, Designs and Patents Act 1988 no extract may be reproduced, stored in a retrieval system or transmitted in any form or by any means – electronic, photocopying, recording or otherwise – without prior written permission from BSI. This does not preclude the free use, in the course of implementing the standard of necessary details such as symbols, and size, type or grade designations. If these details are to be used for any other purpose than implementation then the prior written permission of BSI must be obtained. Details and advice can be obtained from the Copyright & Licensing Manager.

Tel: +44 (0)20 8996 7070 Email: copyright@bsigroup.com

BSI Group Headquarters

389 Chiswick High Road London W4 4AL UK

Tel +44 (0)20 8996 9001

Fax +44 (0)20 8996 7001

www.bsigroup.com/standards

raising standards worldwide™

British Standards Institution (BSI)

BSI is the independent national body responsible for preparing British Standards. It presents the UK view on standards in Europe and at the international level.

It is incorporated by Royal Charter.

Revisions

British Standards are updated by amendment or revision. Users of British Standards should make sure that they possess the latest amendments or editions.

It is the constant aim of BSI to improve the quality of our products and services. We would be grateful if anyone finding an inaccuracy or ambiguity while using this British Standard would inform the Secretary of the technical committee responsible, the identity of which can be found on the inside front cover.

Tel: +44 (0)20 8996 9000 Fax: +44 (0)20 8996 7400

BSI offers members an individual updating service called PLUS which ensures that subscribers automatically receive the latest editions of standards.

Buying standards

Orders for all BSI, international and foreign standards publications should be addressed to BSI Customer Services.

Tel: +44 (0)20 8996 9001 Fax: +44 (0)20 8996 7001

Email: orders@bsigroup.com

You may also buy directly using a debit/credit card from the BSI Shop on the website www.bsigroup.com/shop

In response to orders for international standards, it is BSI policy to supply the BSI implementation of those that have been published as British Standards, unless otherwise requested.

Information on standards

BSI provides a wide range of information on national, European and international standards through its Library.

Various BSI electronic information services are also available which give details on all its products and services. Contact the Information Centre.

Tel: +44 (0)20 8996 7111

Fax: +44 (0)20 8996 7048 Email: info@bsigroup.com

Subscribing members of BSI are kept up to date with standards developments and receive substantial discounts on the purchase price of standards. For details of these and other benefits contact Membership Administration.

Tel: +44 (0)20 8996 7002 Fax: +44 (0)20 8996 7001

Email: membership@bsigroup.com

Information regarding online access to British Standards via British Standards Online can be found at www.bsigroup.com/BSOL

Further information about BSI is available on the BSI website at www.bsigroup.com

Copyright

Copyright subsists in all BSI publications. BSI also holds the copyright, in the UK, of the publications of the international standardization bodies. Except as permitted under the Copyright, Designs and Patents Act 1988 no extract may be reproduced, stored in a retrieval system or transmitted in any form or by any means – electronic, photocopying, recording or otherwise – without prior written permission from BSI. This does not preclude the free use, in the course of implementing the standard of necessary details such as symbols, and size, type or grade designations. If these details are to be used for any other purpose than implementation then the prior written permission of BSI must be obtained. Details and advice can be obtained from the Copyright & Licensing Manager.

Tel: +44 (0)20 8996 7070 Email: copyright@bsigroup.com

BSI Group Headquarters

389 Chiswick High Road London W4 4AL UK

Tel +44 (0)20 8996 9001

Fax +44 (0)20 8996 7001

www.bsigroup.com/standards

raising standards worldwide™